

Article number: 059041265

Description: Hepco cap seal CW 265

Measures

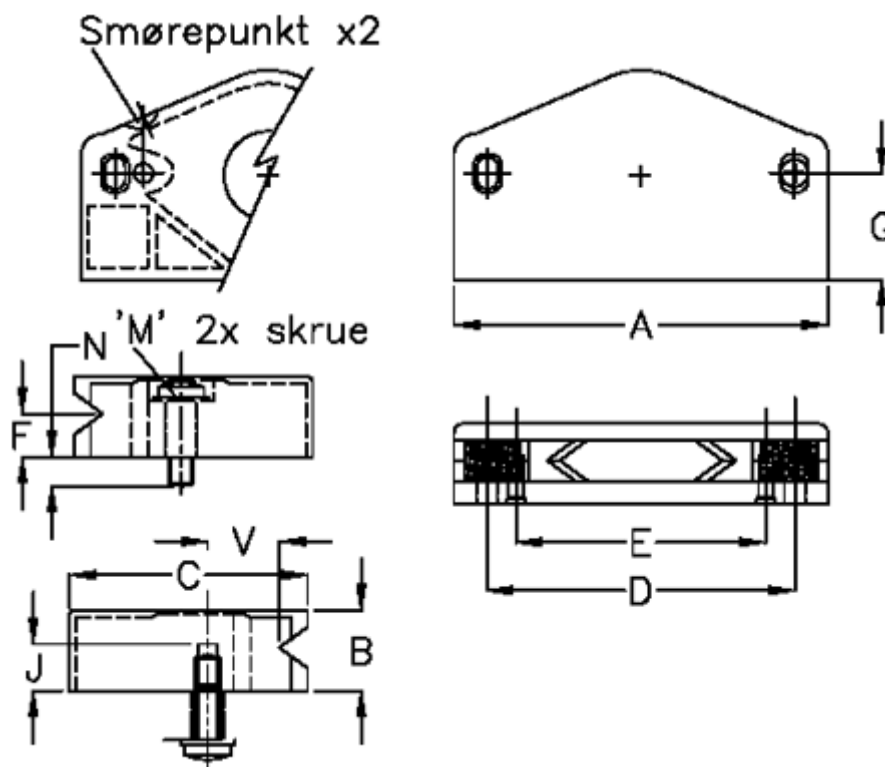

A = 54	M	= M3x16
B = 13.0	N	= 5.5
C = 30.3	V	= 10.0
D = 44	Weight kg/1000 = 0.010	
E = 35.0		
F = 6.8		
G = 15.3		
J = 8.5		